

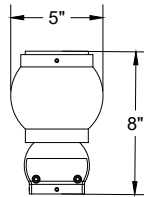

MOUNTING DEVICE

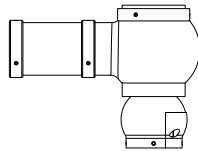

PMD-002-RD

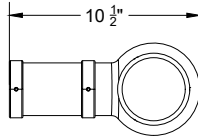

PMD-001-SQ

PMD-001-SQ shown with optional BA Finial (adder)

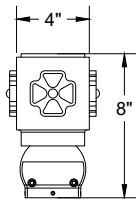
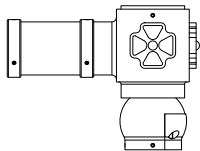
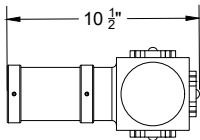

Specifications and Features:

Specifications

All mounting devices fit 2³/₈" horizontal oriented arms attached with six 1¹/₄"-20 set screws.
 Mounting devices (knuckles) are used as levelers for pendant mounted luminaires.

Options (for PMD-001 & PMD-002 only)

- 3-pin twist-lock receptacle (PCR3). Sensor by others.
- 7-pin twist-lock receptacle (PCR7). Sensor by others.
- Finial

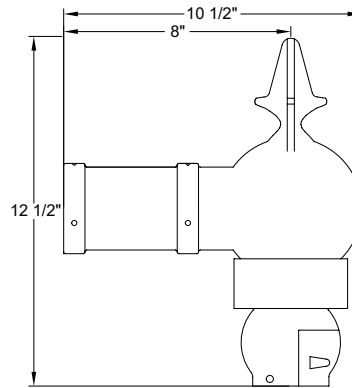

PMD-003-CF

Order Information Example:

PMD001SQNNBK

PMD	Model	Style	Finial	Options	Finish
		001-SQ=Square 002-RD=Round 003-CF=Round Casting with integrated finial	N=None BA=Ball Finial* AC=Acorn Finial* *PMD001 & PMD002 Only	N=None PCR3=3-Pin Twist-Lock Receptacle* PCR7=7-Pin Twist-Lock Receptacle* *PMD001 & PMD002 Only. Photo cell not included.	STANDARD FINISHES BK=Black BZ=Bronze DBZ=Dark Bronze WH=White GR=Green SM=Silver Metallic GY=Light Gray TBK=Textured Black CC=Custom Color (Consult Factory)