



ROADWAY ARMS



Specifications and Features:

Specifications

Arms are constructed out of cast aluminum and are available in 48", 72" or 96".

Mounting: Arms are mounted directly to the pole using hex head bolts and washers. Poles provided by Pemco Lighting will be machined with heavy duty threaded nutserts installed by the factory before finish.

Requirements

Decorative Luminaire Mounting Device (ordered separately on 2nd page) is required for this arm. This device is used for pendant mounted fixtures only. Horizontally mounted fixtures fit directly to a 2 3/8" slip fitter.

Arm Orientation

Standard double arm orientation is 180°. For custom orientation, please contact the factory.

Finish

Super durable polyester powder coat finish. Custom finishes available, including patinas and all RAL colors.

Warranty

5 year limited warranty.



- 48" Single Arm EPA: 2.1
- 48" Double Arm EPA: 4.1
- 72" Single Arm EPA: 3.7
- 72" Double Arm EPA: 5.3
- 96" Single Arm EPA: 3.9
- 96" Double Arm EPA: 6.7
- Weight load per arm: 70 lbs.

Order Information Example:		PLA908SGPM48PENBK			
Model	# of Arms	Arm Mount	Arm Length	Fixture Mount	Finish
PLA908	SG=Single DB=Double	PM=Post/Pole Mount	48=48" 72=72" 96=96"	TEN=Horizontal Tenon Mount PEN=Pendant Mount* *Must order separate Mounting Device (last page)	STANDARD FINISHES BK=Black BZ=Bronze DBZ=Dark Bronze WH=White GR=Green SM=Silver Metallic GY=Light Gray TBK=Textured Black CC=Custom Color (Consult Factory)



ROADWAY ARMS

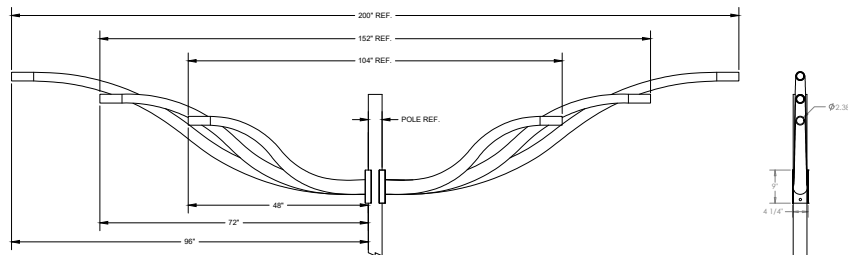
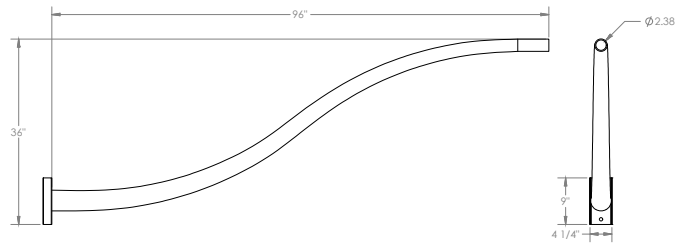
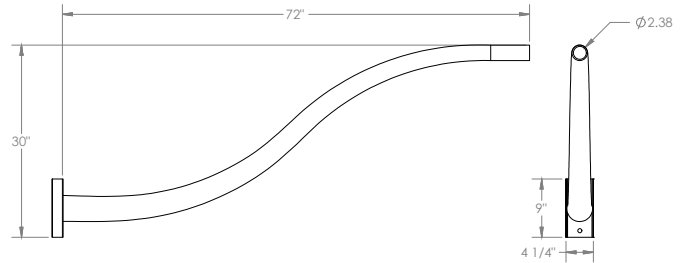
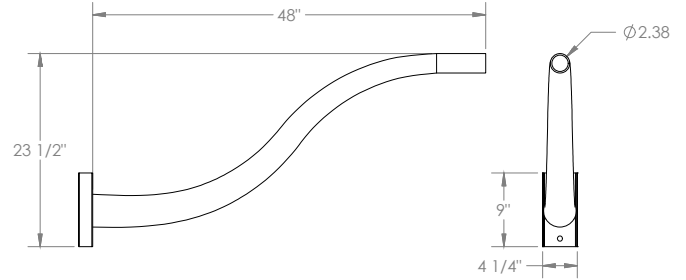



ROADWAY ARMS



PMD-002-RD

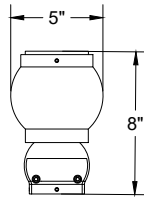
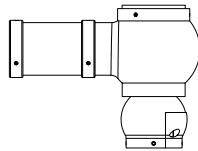
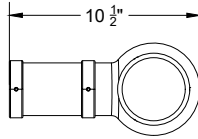

PMD-001-SQ

PMD-001-SQ shown with optional BA Finial (adder)

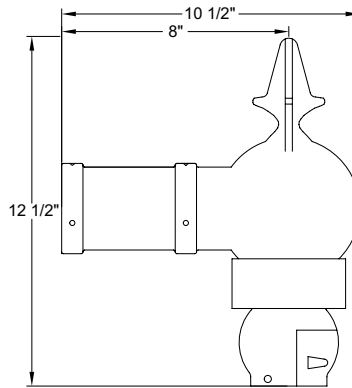
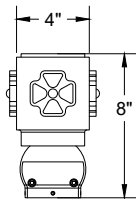
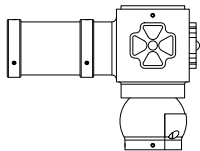
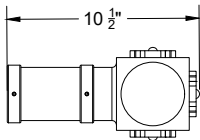

PMD-003-CF

Specifications and Features:

Specifications

All mounting devices fit 2³/₈" horizontal oriented arms attached with six 1¹/₄"-20 set screws. Mounting devices (knuckles) are used as levelers for pendant mounted luminaires.

Options (for PMD-001 & PMD-002 only)

- 3-pin twist-lock receptacle (PCR3). Sensor by others.
- 7-pin twist-lock receptacle (PCR7). Sensor by others.
- Finial

Order Information Example:

PMD001SQNNBK

PMD	Style	Finial	Options	Finish
Model	Style	Finial	Options	Finish
	001-SQ=Square 002-RD=Round 003-CF=Round Casting with integrated finial	N=None BA=Ball Finial* AC=Acorn Finial* *PMD001 & PMD002 Only	N=None PCR3=3-Pin Twist-Lock Receptacle* PCR7=7-Pin Twist-Lock Receptacle* *PMD001 & PMD002 Only. Photo cell not included.	STANDARD FINISHES BK=Black BZ=Bronze DBZ=Dark Bronze WH=White GR=Green SM=Silver Metallic GY=Light Gray TBK=Textured Black CC=Custom Color (Consult Factory)